

Note on English translation:

This is a translation of the technical data sheet valid in Iran.

All stated details and properties are in compliance with the regulations of the local standards and building regulations. They are only applicable for the specified products, system components, application rules, and construction details in connection with the specifications of the respective certificates and approvals. Kplus denies any liability for applications outside of Iran as this requires changes acc. to the respective national standards and building regulations.

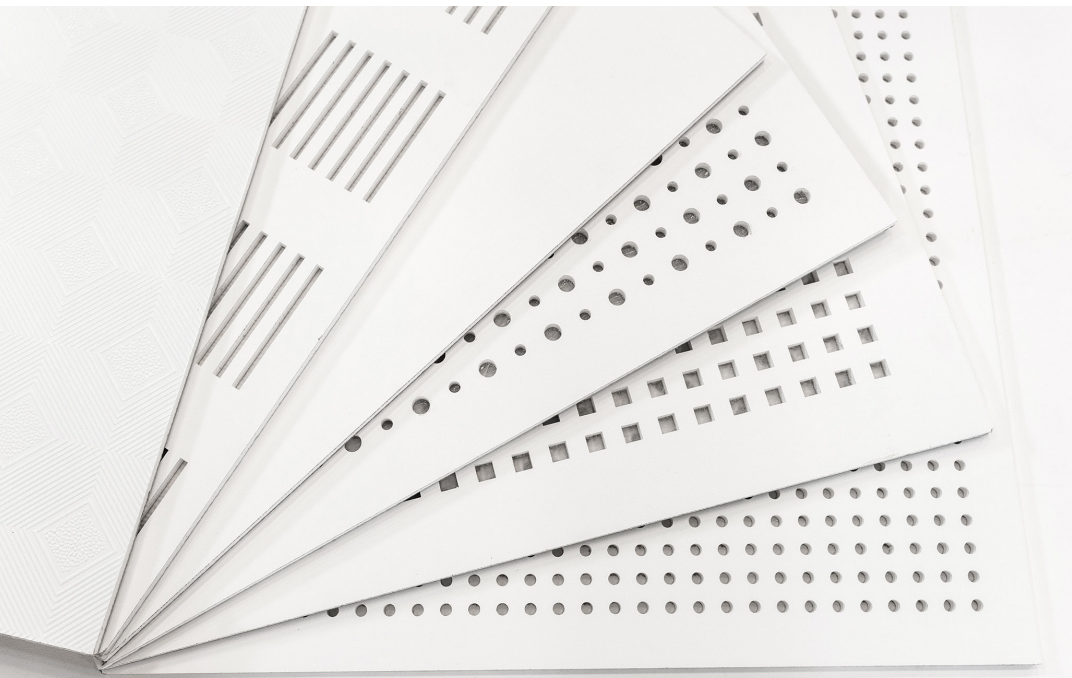

Technical Data Sheet

2022-2023

Gypsum Tile

Product Description

K+ tile ceiling system is a concept of modular suspended ceiling, ideal for concealing mechanical and electrical pipes and cabling as well as air-conditioning ducts. Additional suspended ceilings. Furthermore, K+ perforated ceiling tiles can vastly improve acoustical conditions in indoor areas.

K+ Tile Ceiling System consists of a suspended grid (made of lightweight T 24 profiles) and gypsum tiles. The grid is connected to the main soffit by adjustable hangers and the gypsum tiles are placed in the grid frames.

K+ Ceiling Tiles are gypsum based, 600 x 600 mm tiles which are produced in two varieties: plain (non-perforated) and acoustical (perforated).

Advantages of K+ Gypsum Tile

- Quick and easy installation.
- Superior aesthetic appearance.
- Easy access to M&E installations
- Saving time and money by omitting painting step
- Easy maintenance and repair
- Good sound absorption to improve the acoustic environment

All tiles are made of natural gypsum in accordance with ISIRI 21083 and under the management system ISO 9001.

TILE TYPES OVERVIEW

Product Description			Code	Packing
Plain white painted tile 9.5 mm			442100007330600	520 Pcs
Plain white painted tile 9.5 mm with aluminium coat on back			442100008330600	520 Pcs
Plain PVC laminated tile 9.5 mm (UV resist & Anti-static)			442100002330600	520 Pcs
Plain PVC laminated tile 9.5 mm (UV resist & Anti -static) with aluminium coat on back			442100003330600	520 Pcs
Acoustic circular perforated tile 9.5 mm with fleece layer on back	6-18	White Fleece	452100000330600	520 Pcs
		Black Fleece	452110000330600	
	8-18	White Fleece	452100020330600	
		Black Fleece	452110020330600	
	8-12-36	White Fleece	452100030330600	
		Black Fleece	452110030330600	
	8-12-50	White Fleece	452100040330600	
		Black Fleece	452110040330600	
Acoustic square perforated tile 9.5 mm with fleece layer on back	12-25	White Fleece	452100050330600	520 Pcs
		Black Fleece	452110050330600	
Acoustic linear perforated tile 9.5 mm with fleece layer on back	6-96	White Fleece	452100060330600	520 Pcs
		Black Fleece	452110060330600	
Painted- Acoustic circular perforated tile 9.5 mm with fleece layer on back	6-18	White Fleece	452100007330600	520 Pcs
		Black Fleece	452110007330600	
	8-18	White Fleece	452100027330600	
		Black Fleece	452110027330600	
	8-12-36	White Fleece	452100037330600	
		Black Fleece	452110037330600	
	8-12-50	White Fleece	452100047330600	
		Black Fleece	452110047330600	
Painted -Acoustic square perforated tile 9.5 mm with fleece layer on back	12-25	White Fleece	452100057330600	520 Pcs
		Black Fleece	452110057330600	

Product Description			Code	Packing
Painted -Acoustic linear perforated tile 9.5 mm with fleece layer on back	6-96	White Fleece	452100067330600	520 Pcs
		Black Fleece	452110067330600	
PVC laminated- Acoustic circular perforated tile 9.5 mm with fleece layer on back	6-18	White Fleece	452100002330600	520 Pcs
		Black Fleece	452110002330600	
	8-18	White Fleece	452100022330600	
		Black Fleece	452110022330600	
	8-12-36	White Fleece	452100032330600	
		Black Fleece	452110032330600	
	8-12-50	White Fleece	4521000423300600	
		Black Fleece	4521100423300600	
PVC laminated- Acoustic square perforated tile 9.5 mm with fleece layer on back	12-25	White Fleece	452100052330600	520 Pcs
		Black Fleece	452110052330600	
PVC laminated- Acoustic linear perforated tile 9.5 mm with fleece layer on back	6-96	White Fleece	452100062330600	520 Pcs
		Black Fleece	452110062330600	
PVC laminated-moisture resist tile 9.5 mm			442600002330600	520 Pcs
PVC laminated-Decorative tile 9.5 mm			44260000333060	520 Pcs
PVC laminated-Decorative tile 9.5 mm	238	Rouby	442100022380600	520 Pcs
	239	Diamond	442100022390600	
	567	Lozenge	442100025670600	
	996	Wicker	442100029960600	
PVC laminated-Decorative tile 9.5 mm with aluminium coat on back	238	Rouby	442100032380600	520 Pcs
	239	Diamond	442100032390600	
	567	Lozenge	442100035670600	
	996	Wicker	442100039960600	

Product information (plain tile)

Tile Size	THICKNESS(mm)	Nominal WIDTH(mm)	Nominal LENGTH(mm)	WEIGHT(kg/m ²)
	9.5	600	600	7.7
EDGE TYPE	SK			
LIGHT REFLECTANCE	Painted : _		PVC laminated : 89%	
THERMAL R-VALUE	0.04			
COLOR	WHITE			
SYSTEM	EXPOSED GRID SUBSTRATE			
PERCENTAGE OF PERFORATION	0			
FIRE HAZZARD PROPERTIES	A2-S1,d0		NON-FLAMMABLE B1-S1,d0	
MOISTURE RESISTANCE	UP to 60%			

APPLICATION

This Plain (non-perforated) tile produce in vary of colors for multi usages. It could be produce in two types:

- Non-laminated
- PVC laminated (front side) and / or aluminum foil laminated (backside)

PVC laminated tiles have capability for easy cleaning, backside laminated ones is applied for areas with risk of condensation and water droplets such as pipes throw under ceilings if conditioning control is available.

Painted tiles are covered by specific white antistatic & antibacterial color, this coat has key role for prevention of growing molds and other microorganisms on ceiling's surface.

Product information (Tile 12/25)

Tile Size	THICKNESS(mm)	Nominal WIDTH(mm)	Nominal LENGTH(mm)	WEIGHT(kg/m ²)
	9.5	600	600	5.9
EDGE TYPE	SK			
LIGHT REFLECTANCE	Painted : _		PVC laminated : 89%	
THERMAL R-VALUE	-			
COLOR	WHITE			
SYSTEM	EXPOSED GRID SUBSTRATE			
PERCENTAGE OF PERFORATION	23%			
FIRE HAZZARD PROPERTIES	A2-S1,d0		NON-FLAMMABLE B1-S1,d0	
MOISTURE RESISTANCE	UP to 50%			

APPLICATION

Perforated tiles are used for internal ceiling lining systems where it is necessary to control sound reverberation and improve the acoustic environment.

They are ideal in large open spaces or high traffic areas where there is an acoustic and aesthetic requirement, including office environments, foyers and other public buildings.

PERFORMANCE

Dimension of square perforation is shown in the picture, furthermore acoustical properties included in the below chart.

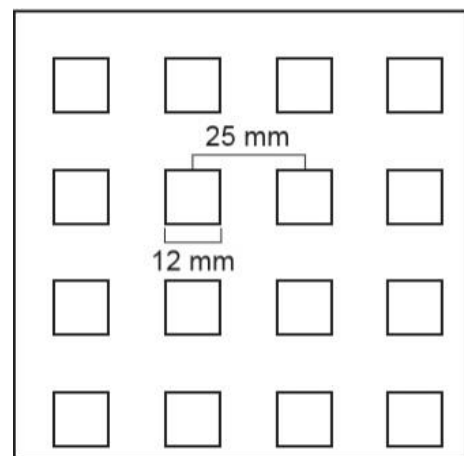
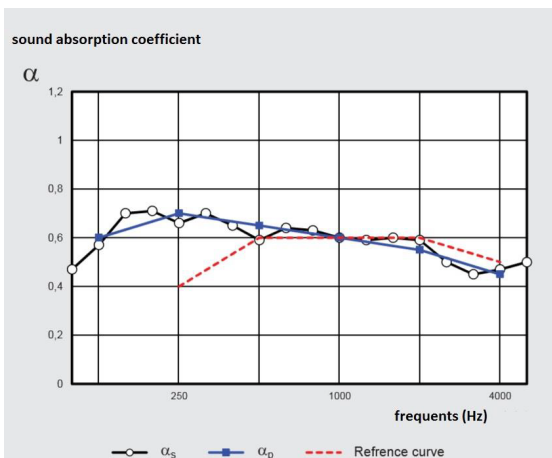

$\alpha_w = 0.6$ - NRC=0.6 without mineral wool, plenum space = 40 cm

Product information (Tile 6/18)

Tile Size	THICKNESS(mm)	Nominal WIDTH(mm)	Nominal LENGTH(mm)	WEIGHT(kg/m ²)
	9.5	600	600	7
EDGE TYPE	SK			
LIGHT REFLECTANCE	Painted : _		PVC laminated : 89%	
THERMAL R-VALUE	-			
COLOR	WHITE			
SYSTEM	EXPOSED GRID SUBSTRATE			
PERCENTAGE OF PERFORATION	8.7%			
FIRE HAZARD PROPERTIES	A2-S1,d0		NON-FLAMMABLE B1-S1,d0	
MOISTURE RESISTANCE	UP to 50%			

APPLICATION

Perforated tiles are used for internal ceiling lining systems where it is necessary to control sound reverberation and improve the acoustic environment.

They are ideal in large open spaces or high traffic areas where there is an acoustic and aesthetic requirement, including office environments, foyers and other public buildings.

PERFORMANCE

Dimension of square perforation is shown in the picture, furthermore acoustical properties included in the below chart.

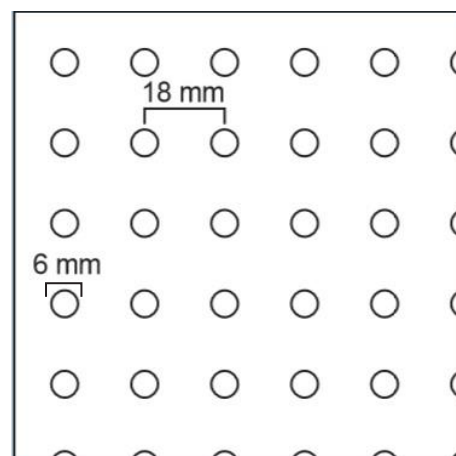
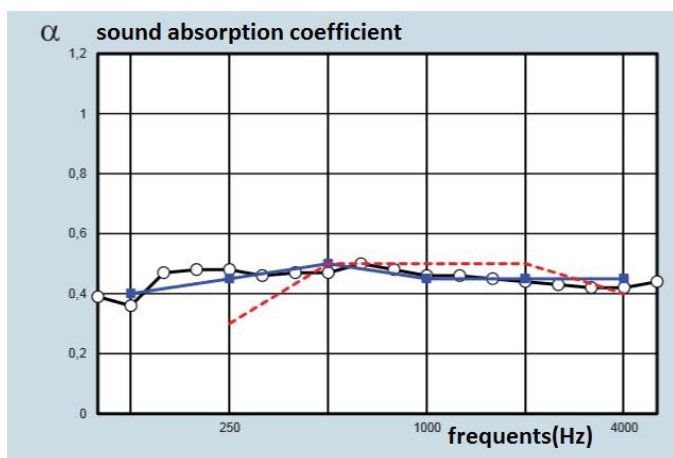

$\alpha_w = 0.5$ - NRC=0.45 without mineral wool, plenum space = 40 cm

Product information (Tile 8/12/36)

Tile Size	THICKNESS(mm)	Nominal WIDTH(mm)	Nominal LENGTH(mm)	WEIGHT(kg/m ²)
	9.5	600	600	6.7
EDGE TYPE	SK			
LIGHT REFLECTANCE	Painted : _		PVC laminated : 89%	
THERMAL R-VALUE	-			
COLOR	WHITE			
SYSTEM	EXPOSED GRID SUBSTRATE			
PERCENTAGE OF PERFORATION	12.6%			
FIRE HAZARD PROPERTIES	A2-S1,d0		NON-FLAMMABLE B1-S1,d0	
MOISTURE RESISTANCE	UP to 50%			

APPLICATION

Perforated tiles are used for internal ceiling lining systems where it is necessary to control sound reverberation and improve the acoustic environment.

They are ideal in large open spaces or high traffic areas where there is an acoustic and aesthetic requirement, including office environments, foyers and other public buildings.

PERFORMANCE

Dimension of square perforation is shown in the picture, furthermore acoustical properties included in the below chart.

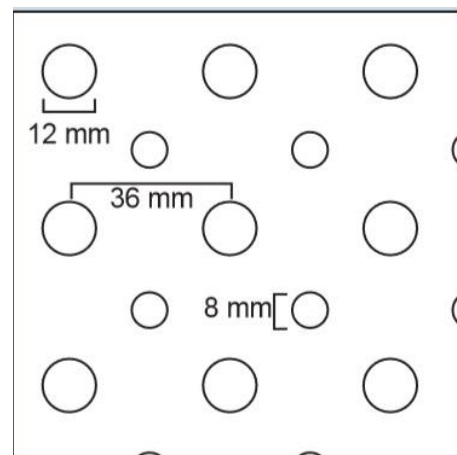
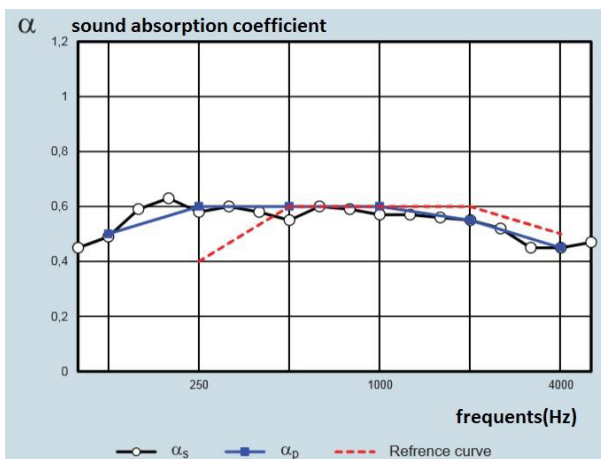

$\alpha_w = 0.6$ - NRC=0.6 without mineral wool, plenum space = 40 cm

Product information (Tile 8/12/50)

Tile Size	THICKNESS(mm)	Nominal WIDTH(mm)	Nominal LENGTH(mm)	WEIGHT(kg/m ²)
	9.5	600	600	6.7
EDGE TYPE	SK			
LIGHT REFLECTANCE	Painted : _		PVC laminated : 89%	
THERMAL R-VALUE	-			
COLOR	WHITE			
SYSTEM	EXPOSED GRID SUBSTRATE			
PERCENTAGE OF PERFORATION	13.1%			
FIRE HAZZARD PROPERTIES	A2-S1,d0		NON-FLAMMABLE B1-S1,d0	
MOISTURE RESISTANCE	UP to 50%			

APPLICATION

Perforated tiles are used for internal ceiling lining systems where it is necessary to control sound reverberation and improve the acoustic environment.

They are ideal in large open spaces or high traffic areas where there is an acoustic and aesthetic requirement, including office environments, foyers and other public buildings.

PERFORMANCE

Dimension of square perforation is shown in the picture, furthermore acoustical properties included in the below chart.

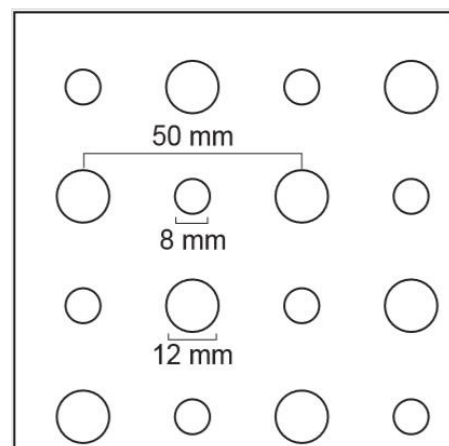
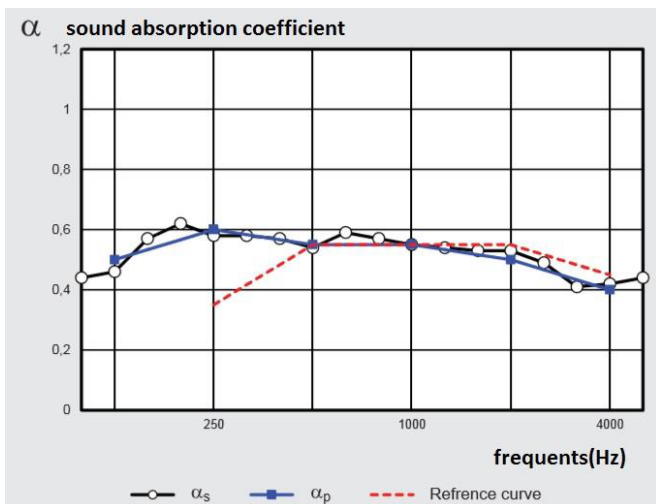

$\alpha_w = 0.55$ - NRC=0.55 without mineral wool, plenum space = 40 cm

Product information (Tile 8/18)

Tile Size	THICKNESS(mm)	Nominal WIDTH(mm)	Nominal LENGTH(mm)	WEIGHT(kg/m ²)
	9.5	600	600	6.5
EDGE TYPE	SK			
LIGHT REFLECTANCE	Painted : _		PVC laminated : 89%	
THERMAL R-VALUE	-			
COLOR	WHITE			
SYSTEM	EXPOSED GRID SUBSTRATE			
PERCENTAGE OF PERFORATION	15.5%			
FIRE HAZARD PROPERTIES	A2-S1,d0		NON-FLAMMABLE B1-S1,d0	
MOISTURE RESISTANCE	UP to 50%			

APPLICATION

Perforated tiles are used for internal ceiling lining systems where it is necessary to control sound reverberation and improve the acoustic environment.

They are ideal in large open spaces or high traffic areas where there is an acoustic and aesthetic requirement, including office environments, foyers and other public buildings.

PERFORMANCE

Dimension of square perforation is shown in the picture, furthermore acoustical properties included in the below chart.

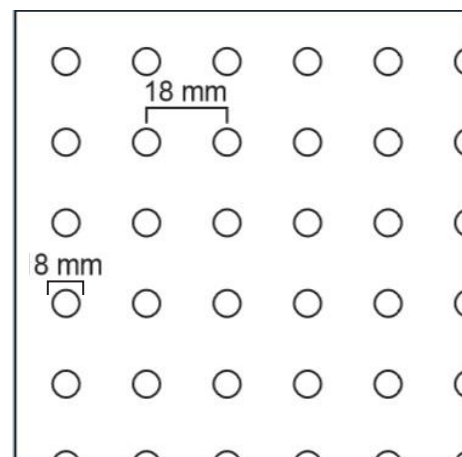
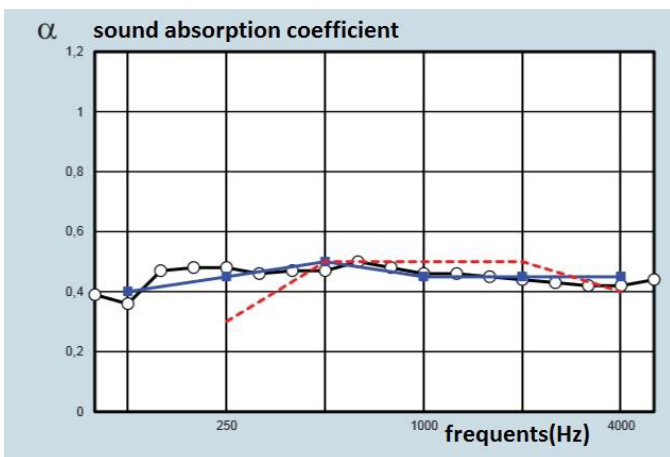

$\alpha_w = 0.6$ - NRC=0.6 without mineral wool, plenum space = 40 cm

Product information (PVC laminated Decorative tile)

Tile Size	THICKNESS(mm)	Nominal WIDTH(mm)	Nominal LENGTH(mm)	WEIGHT(kg/m ²)
	9.5	600	600	7.5
EDGE TYPE	SK			
LIGHT REFLECTANCE	PVC laminated : 89%			
THERMAL R-VALUE	0.04			
COLOR	WHITE			
SYSTEM	EXPOSED GRID SUBSTRATE			
PERCENTAGE OF PERFORATION	0			
FIRE HAZZARD PROPERTIES	A2-S1,d0		NON-FLAMMABLE B1-S1,d0	
MOISTURE RESISTANCE	UP to 60%			

APPLICATION

PVC laminated decorative tiles have capability for easy cleaning, backside laminated ones is applied for areas with risk of condensation and water droplets such as pipes throw under ceilings if conditioning control is available.

The Decorative tiles are produced in four types:

- Ruby 238
- Diamond 239
- Lozenge 567
- Wicker 996

Product information (Tile 6/96)

Tile Size	THICKNESS(mm)	Nominal WIDTH(mm)	Nominal LENGTH(mm)	WEIGHT(kg/m ²)
		9.5	600	600
EDGE TYPE	SK			
LIGHT REFLECTANCE	Painted : _		PVC LAMINATED: 89%	
THERMAL R-VALUE	0.04			
COLOR	WHITE			
SYSTEM	EXPOSED GRID SUBSTRATE			
PERCENTAGE OF PERFORATION	17.85%			
FIRE HAZARD PROPERTIES	A2-S1,d0		NON-FLAMMABLE B1-S1,d0	
MOISTURE RESISTANCE	UP to 50%			

APPLICATION

Perforated tiles are used for internal ceiling lining systems where it is necessary to control sound reverberation and improve the acoustic environment.

They are ideal in large open spaces or high traffic areas where there is an acoustic and aesthetic requirement, including office environments, foyers and other public buildings.

PERFORMANCE

Dimension of square perforation is shown in the picture, furthermore acoustical properties included in the below chart.

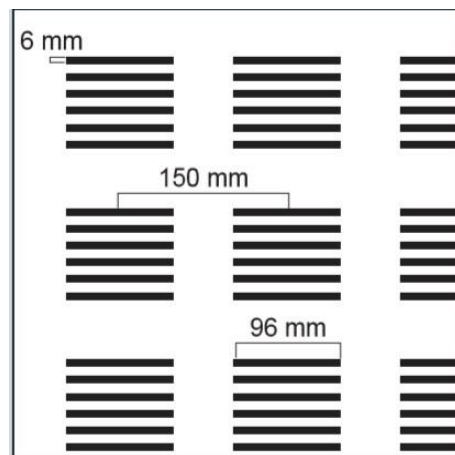
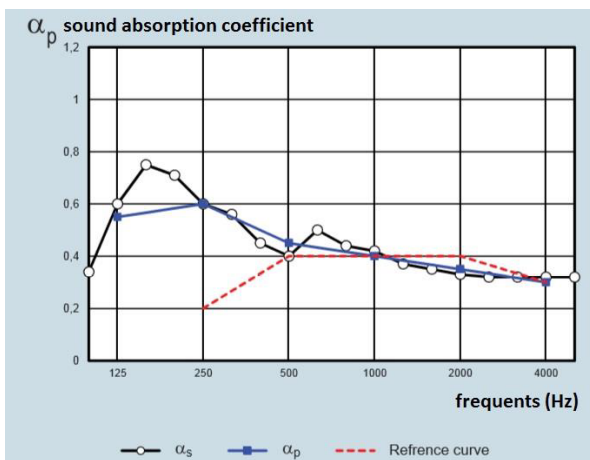

$\alpha_w = 0.4$ - NRC=0.45 without mineral wool, plenum space = 40 cm

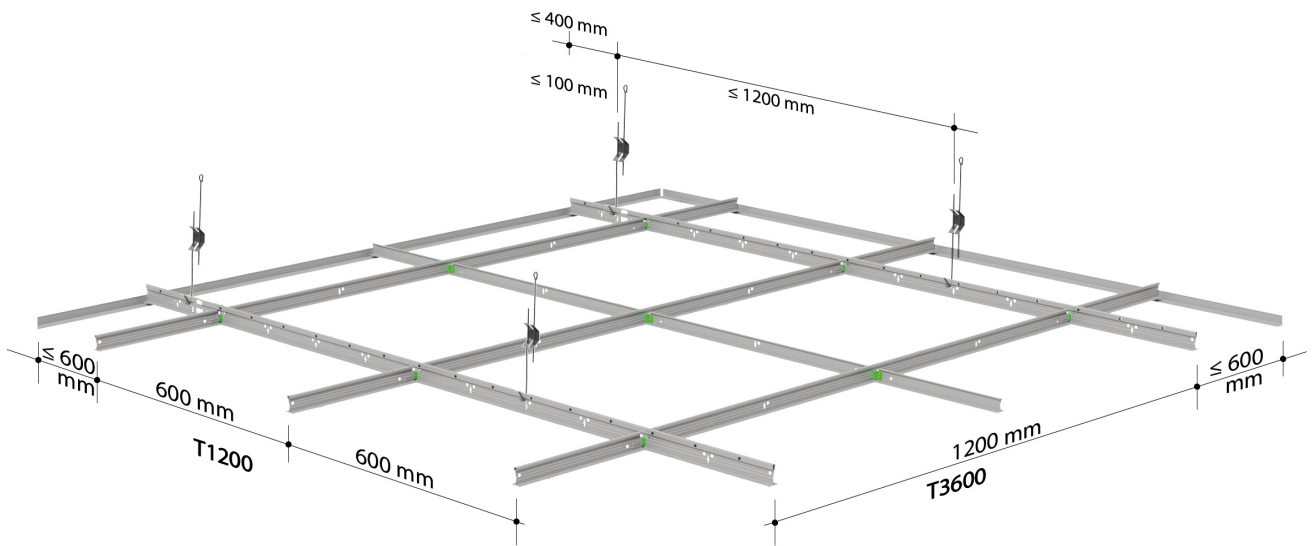

1. Fixing the perimeter L-<-hannel

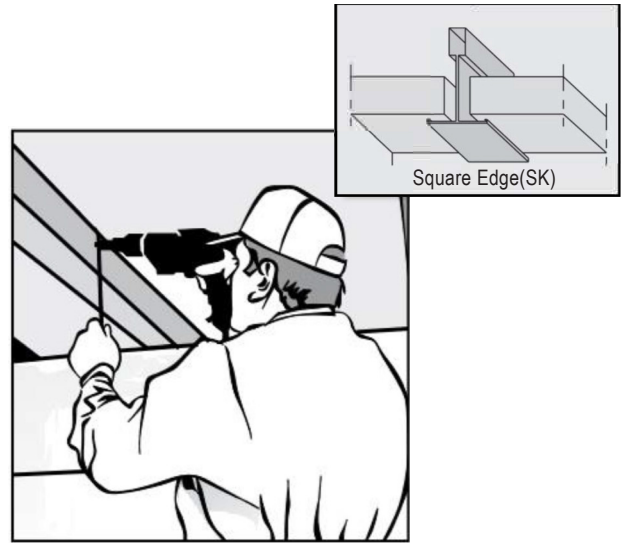

2. Fixing the hangers to the main soffit



3. Installing the suspended grid

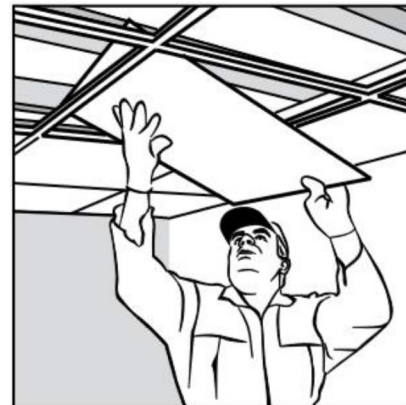

4. Placing the tiles in the grid frames

Gypsum Tile

INSTALATION

The Perimeter Angle L-channel is installed flush on the side walls with plastic plug and screws centered at 60 cm. Mark the position of the K+ hanger wires on the ceiling before attaching them with K+ ceiling steel dowels to the ceilings. If lighting fixtures or basic audio equipment is to be attached, provide extra on-site bracing in order to avoid any conflict with the overall suspended ceiling system. Suspend the main bearing T 24 channels using adjustable hanger wires and double cleats. Install intermediate bearing T 24 channels on main bearing T 24 channels to make up a flush 60 x 60 grid. Ensure that the grid is totally flush. Finally, install K+ Ceiling Tiles as required.

Alignment The alignment between main bearing members and intermediate bearing members of the ceiling grid must be mutually perpendicular at all points. Fasten hanger wires rigidly to avoid the sagging of ceiling loads. Main and intermediate bearing members should not be attached on L-Channels. This way the ceiling grid is free to adapt to movements in the main structure.

Loads If any other fixtures or insulation material are being used, include their weight during load calculation procedures.

Kplus Direct:
Technical Support Dept.

- ▶ Phone: (+98 21) 88207929
- ▶ Fax : (+98 21) 88203126
- ▶ technical@kplus.ir

All technical changes reserved. Only the current printed instructions are valid. Our warranty is expressly limited to our products in flawless condition. All application quantities and delivery amounts are based on empirical data that are not easily transferable to other deviating areas. The stated information represents current state-of-the-art Kplus technology. The entire state of approved engineering rules, appropriate standards, guidelines, and rules of craftsmanship are not included herewith. These and all application instructions have to be adhered to separately by the installer.

All rights reserved. All amendments, reprints and photocopies, including those of excerpts, require the express permission of Kplus.

www.kplus.ir

Head Office:

No. 19, East Qobadian Alley, Nelson Mandela (Africa) Blvd., 19176-34611, Tehran, Iran